

e-motion handle

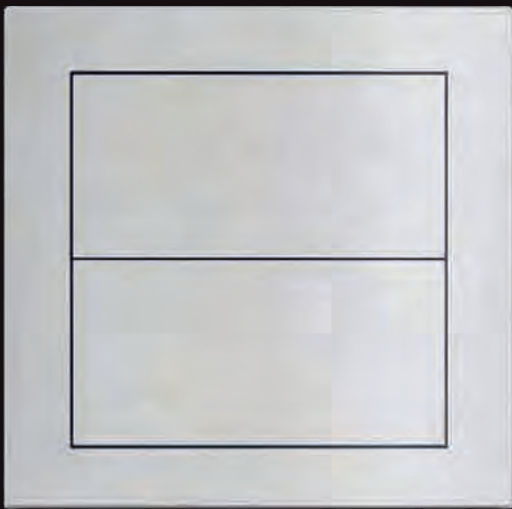

*more than just
a **handle***





All types of *e-motion handle* include a damper. The two flap covers close softly through an integrated damper.

e-motion handle

STANDS FOR FUNCTION AND BEAUTY IN YOUR HOME,
FOR DRAWER, CABINET OR DOOR SIMPLY A PERFECT
SOLUTION. A UNIQUE HANDLE MEETS SPECIAL NEEDS.

DRAWER, CABINET PAGE 4-9

SLIDING DOOR PAGE 10-15



SINGLE FLAP
Just one flap cover can be pushed for opening

DOUBLE FLAP
The two flap covers can be pushed for opening

FUNCTION

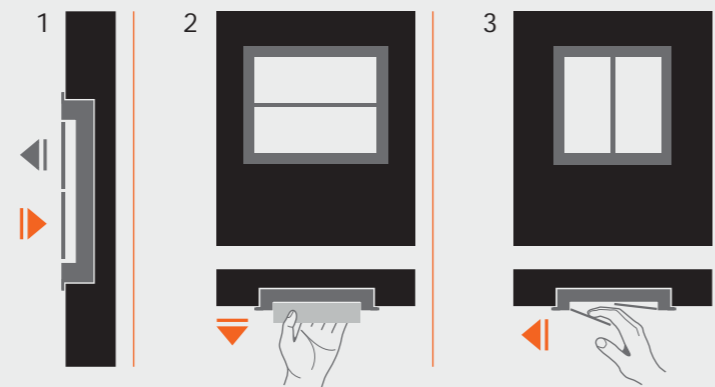

1. The two flap covers include an integrated damper
2. Opening a drawer or cabinet
3. Opening a sliding door

- » Handle surface flush with the furniture front (only 0,8 mm)
- » Soft closing through an integrated damper
- » When opening the handle, a full pull-out appears
- » Plane smooth surface provides an integrated appearance
- » Unlimited variations of design

a handle for

AN OVERALL CONCEPT FOR EACH FURNITURE IN EVERY ROOM. KITCHEN, BATH, BED OR LIVING ROOM
e-motion handle FOR UNIFORM LOOK IN ALL ROOMS.





e-motion standard

IN OUR STANDARD LINE WE OFFER THREE SIZES
CAN BE USED ON DIFFERENT FURNITURE TYPES.
DECENT AND ELEGANT HIGHLIGHTS INCLUDED.



TYP L standard



TYP M standard



TYP S standard



TYP S LED



Special model on request!
LED flashes every 3 sec., lifespan
of battery cell approx. 2 years.

DIMENSION

Typ L standard L 152 mm, B 87 mm
Typ M standard L 112 mm, B 87 mm
Typ S st. / LED L 74 mm, B 74 mm

Art.No.	STAINLESS LOOK	ALUMINIUM LOOK	WHITE SEMIMAT
TYP L st.	1101	1103	1107
TYP M st.	1201	1203	1207
TYP S st.	1401	1403	1407
TYP S LED	1501	1503	1507

FUNCTION

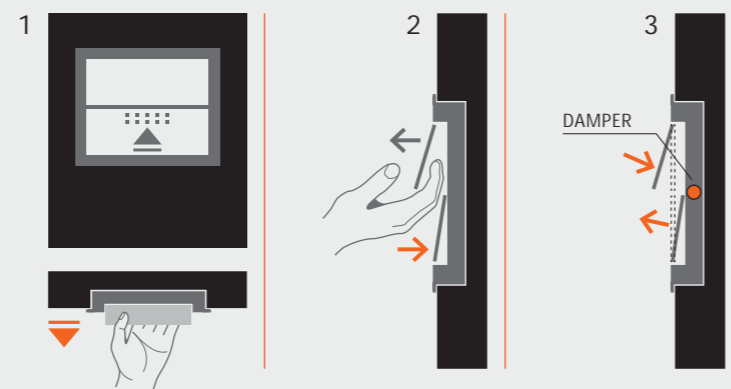

1. Only the lower flap cover can be pushed (Single Flap!)
2. By pushing the lower flap cover, the upper flap opens automatically and a full pull appears
3. The two flap covers close softly through an integrated damper

- » The lower flap cover includes a decent painting
- » On Typ S and S LED flap cover can be removed by simple snapping mechanism
- » Flap covers can be painted individually

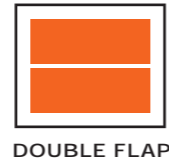

e-motion special

SIMPLY EASY TO USE, THE SPECIAL LINE SHOWS CLEAN AND TIMELESS DESIGN. WITH INTEGRATED DOUBLE FLAP, THIS HANDLE PRESENTS A PERFECT SOLUTION.



TYP R special

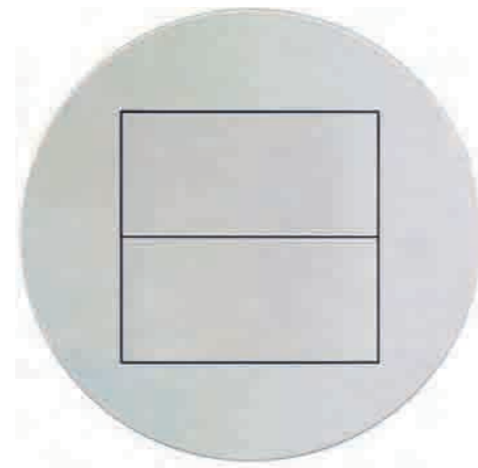

Special models and designs upon request!

TYP L special



TYP S special



Typ L special and Typ S special available from september 2012

DIMENSION

Typ L special L 152 mm, B 87 mm
Typ S special L 74 mm, B 74 mm

FUNCTION

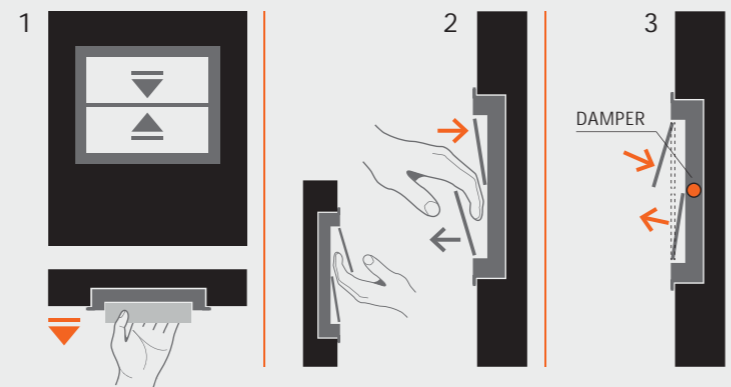

1. The two flap covers can be pushed inside (Double Flap!)
2. Handle allows pulling in both ways, flaps move simultaneously in the opposite direction
3. The two flap covers close softly through an integrated damper

- » Unique and timeless design for highest requirements
- » Double function by flaps in both ways (Double Flap)
- » Soft closing of both flaps through an integrated damper

Art.No.	STAINLESS LOOK	ALUMINIUM LOOK	WHITE SEMIMAT
TYP L sp.	1131	1133	1137
TYP S sp.	1411	1413	1417

this door handle

ALLOWS EVERY ROOM HIS OWN INDIVIDUALITY.
THIS ELEGANT *e-motion handle* FOR SLIDING DOORS
OPENS EVERY ROOM WITH PERFECTION AND STYLE.



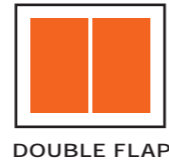

e-motion special

SIMPLY EASY TO USE, THE SPECIAL LINE SHOWS CLEAN AND TIMELESS DESIGN. WITH INTEGRATED DOUBLE FLAP, THIS HANDLE PRESENTS A PERFECT SOLUTION.



TYP L special +

When used on both sides, handles are mounted together by screws. The screws are covered by two cover caps.



TYP L special

Available from september 2012.



DIMENSION

Typ L special+ L 152 mm, B 87 mm
Typ L special L 152 mm, B 87 mm

FUNCTION

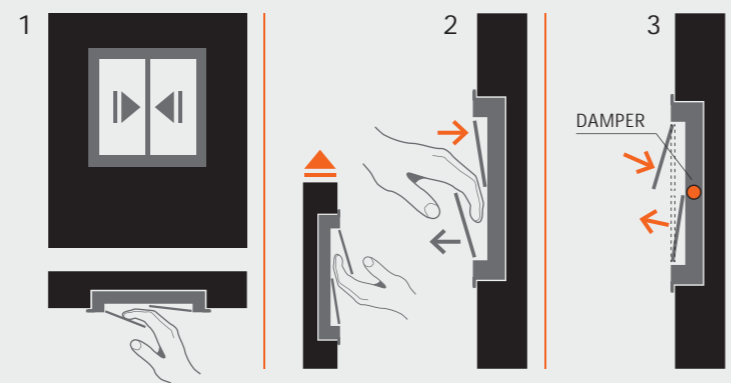

1. The two flap covers can be pushed inside (Double Flap!)
2. Handle allows pulling in both ways, flaps move simultaneously in the opposite direction
3. The two flap covers close softly through an integrated damper

- » Unique and timeless design for highest requirements
- » Double function by flaps in both ways (Double Flap)
- » Soft closing of both flaps through an integrated damper

Art.No.	STAINLESS LOOK	ALUMINIUM LOOK	WHITE SEMIMAT
TYP L sp. +	1311	1313	1317
TYP L sp.	1131	1133	1137

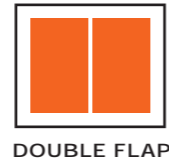

e-motion special

EVERY ROOM IS UNIQUE AND THE DOOR OPENS NEW IMPRESSIONS. *e-motion handle* OFFERS A RANGE OF POSSIBILITIES FOR EXCLUSIVITY AND SPECIAL HIGHLIGHTS.

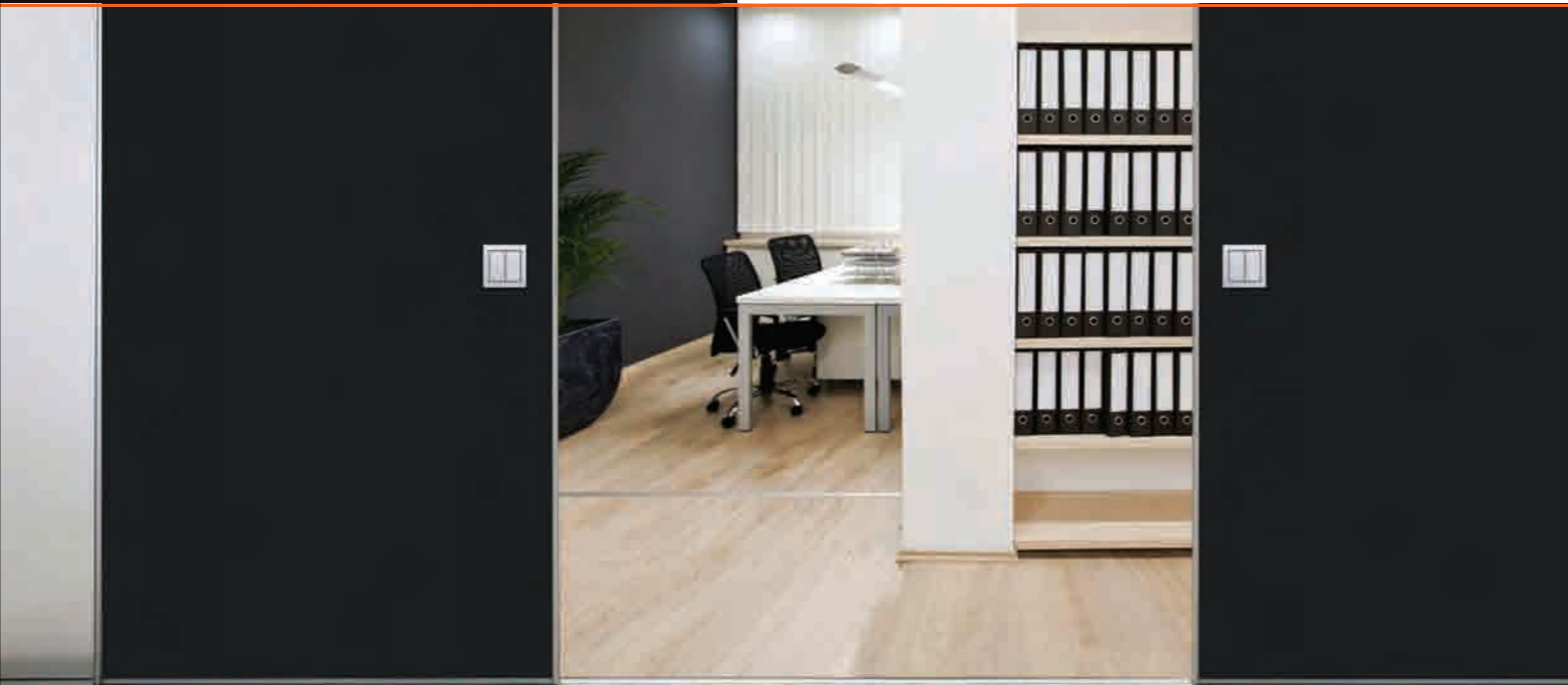

TYP S special



Typ L special and Typ S special available from september 2012

TYP R special

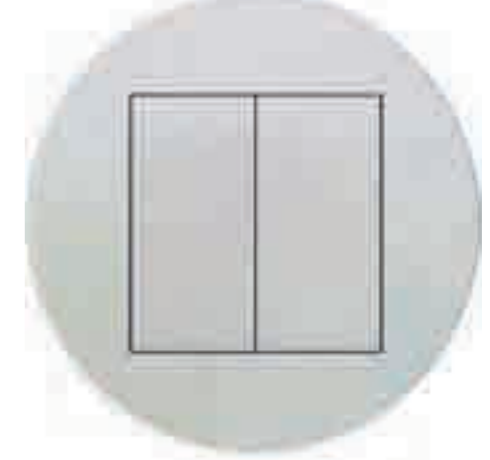

Special models and designs upon request!

DIMENSION

Typ S special L 74 mm, B 74 mm

FUNCTION

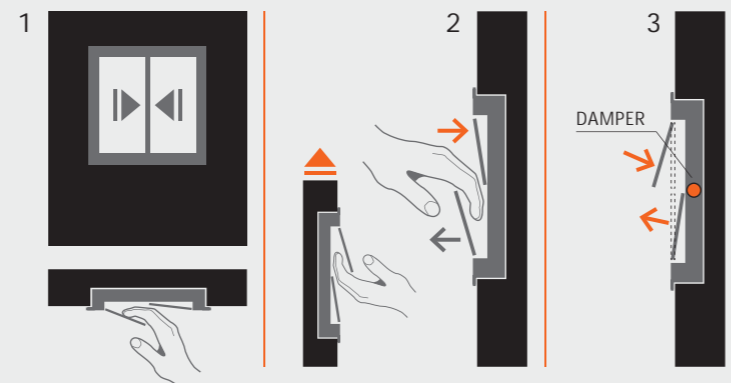

1. The two flap covers can be pushed inside (Double Flap!)
2. Handle allows pulling in both ways, flaps move simultaneously in the opposite direction
3. The two flap covers close softly through an integrated damper

- » Unique and timeless design for highest requirements
- » Double function by flaps in both ways (Double Flap)
- » Soft closing of both flaps through an integrated damper

Art.No.	STAINLESS LOOK	ALUMINIUM LOOK	WHITE SEMIMAT
TYP S sp.	1411	1413	1417

e-motion colours

COMPLETE THE WHOLE CONCEPT. CLASSIC SURFACES LIKE STAINLESS STEEL, ALUMINIUM AND WHITE FOR SUPREME REQUIREMENT. SOLID, MADE FOR THE DAILY USE.



STAINLESS LOOK



ALUMINIUM LOOK



WHITE SEMIMAT



STANDARD LINE

Art.No.	STAINLESS LOOK	ALUMINIUM LOOK	WHITE SEMIMAT
TYP L st.	1101	1103	1107
TYP M st.	1201	1203	1207
TYP S st.	1401	1403	1407
TYP S LED	1501	1503	1507

SPECIAL LINE

Art.No.	STAINLESS LOOK	ALUMINIUM LOOK	WHITE SEMIMAT
TYP L sp.+	1311	1313	1317
TYP L sp.	1131	1133	1137
TYP S sp.	1411	1413	1417

- » Surfaces in stainless steel, aluminium and white semimat as standard range
- » Robust and easy-care surface property
- » Other surfaces and colours on request (minimum 1000 pcs.)

e-motion assembly

JUST TAKE THE RIGHT TOOL AND START! TIME SAVING
BECAUSE OF QUICK AND SIMPL ASSEMBLY.

DRAWER, CABINET

SLIDING DOOR

Typ L standard

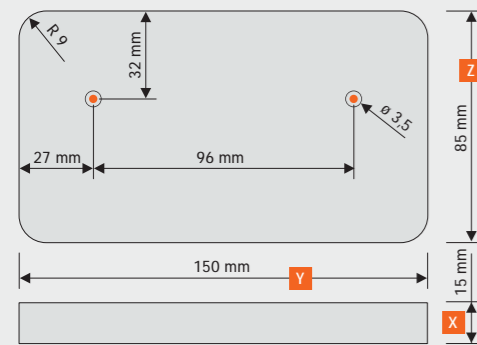

- X » Depth of milled hole min. 15 mm
- Y » Length of milled hole min. 150 mm
- Z » Width of milled hole min. 85 mm

Typ M standard

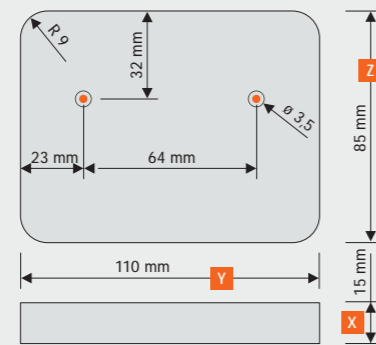

- X » Depth of milled hole min. 15 mm
- Y » Length of milled hole min. 110 mm
- Z » Width of milled hole min. 85 mm

Typ S special (Handle on one side mounted)

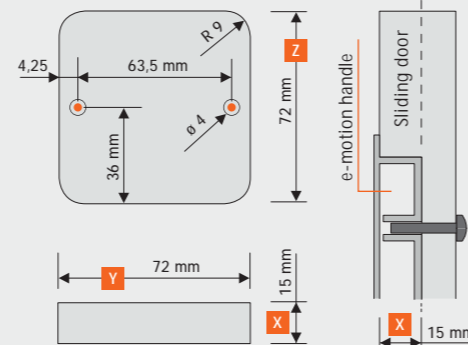

- X » Depth of milled hole min. 15 mm
- Y » Length of milled hole min. 72 mm
- Z » Width of milled hole min. 72 mm

Typ L special / L special+ (Handle on one side mounted)

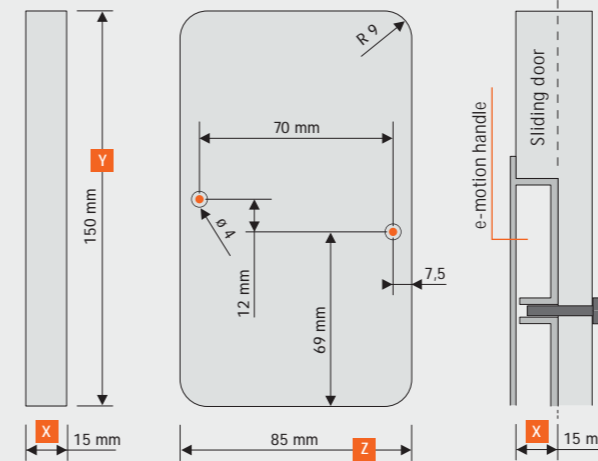

- X » Depth of milled hole min. 15 mm
- Y » Length of milled hole min. 150 mm
- Z » Width of milled hole min. 85 mm

Typ L special+ (Handle on both sides mounted)

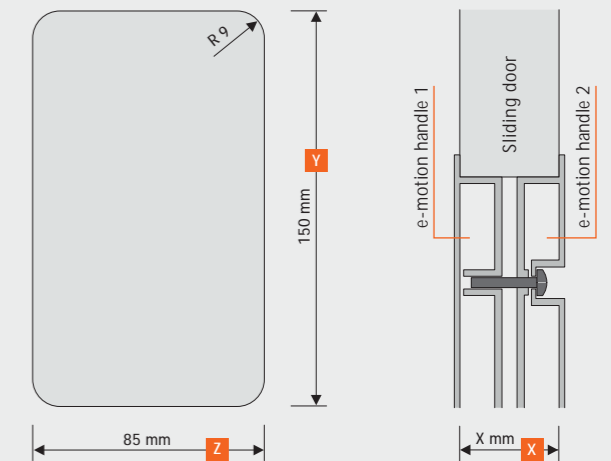

- X » Depth of milled hole X mm (depth sliding door)
- Y » Length of milled hole min. 150 mm
- Z » Width of milled hole min. 85 mm

Typ L special

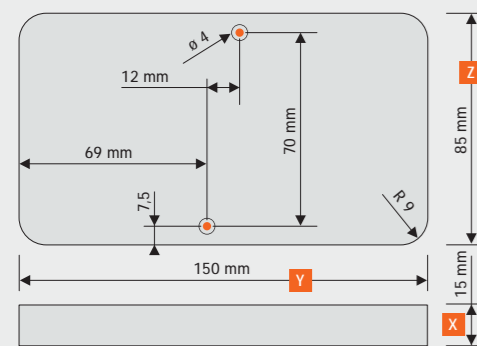

- X » Depth of milled hole min. 15 mm
- Y » Length of milled hole min. 150 mm
- Z » Width of milled hole min. 85 mm

Typ S standard / S special / S LED

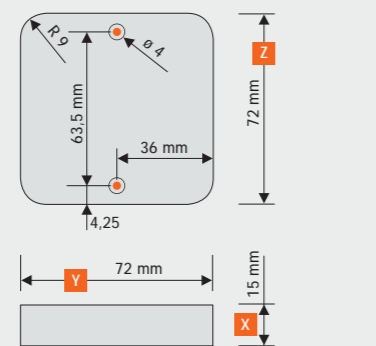

- X » Depth of milled hole min. 15 mm
- Y » Length of milled hole min. 72 mm
- Z » Width of milled hole min. 72 mm

INSTRUCTION

All *e-motion handles* can be mounted on one side with screws at drawer plate or door leaf.

Mounting the handle on both sides of sliding door the milled hole goes through the door plate.

The types **L** and **S special** have to be glued on side surfaces.

Typ **L special+** has to be mounted with screws.

Typ L + S special (Handle on both sides glued)

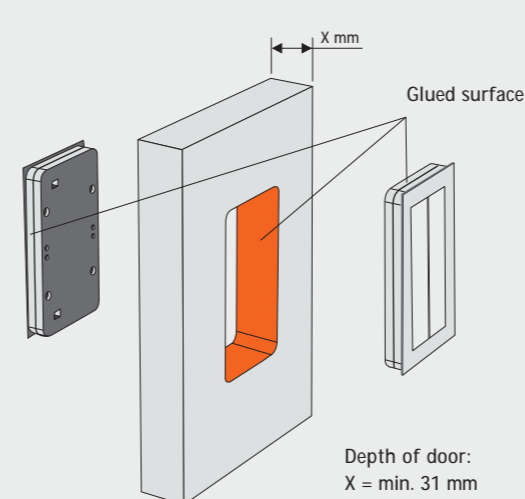

Typ L special+ (Handle on both sides screwed)

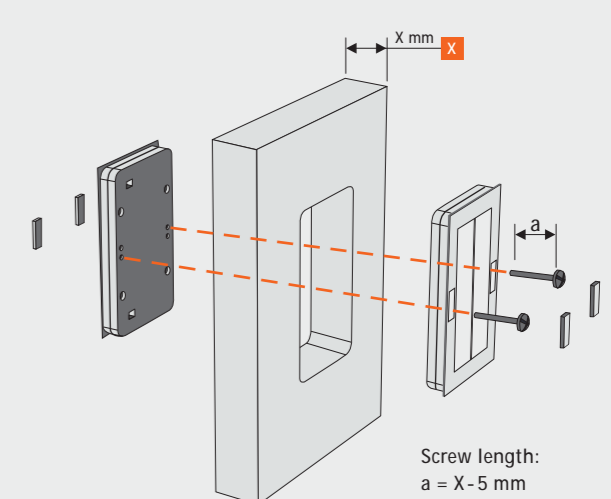

e-motion handle

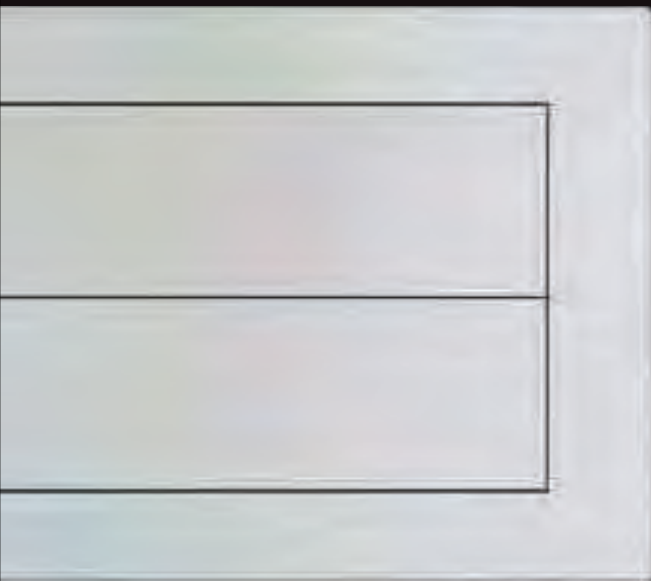

Take your *choice!*

FORM ORANGE

Sägewerkstrasse 50 · A-6971 Hard · Austria (Europe)

T +43 (0) 55 74 | 65 05 5 · F +43 (0) 55 74 | 65 05 54

form_orange@telemax.at · www.form-orange.com